

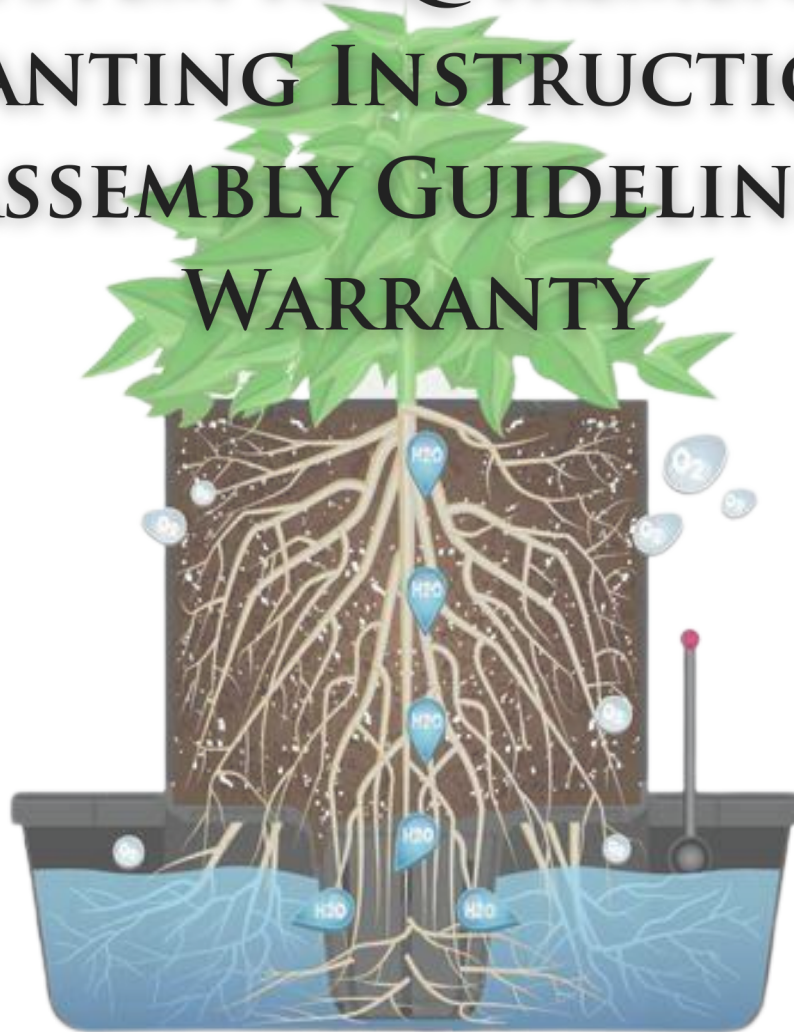

HYBRID GROW SYSTEMS
POWER THE FLOWER

SYSTEM REQUIREMENTS
PLANTING INSTRUCTIONS
ASSEMBLY GUIDELINES
WARRANTY



OCTOPOT, LLC

sales@octopot.com +1-855-628-6768

Revised 10/22/2021

Congratulations

**Get ready to make the most out of Soil & Hydroponics in this Hybrid Grow System!
Thank you for investing in a new way to grow!**

A note from the Inventor, Christopher Jaworski:
*Your valued purchase is promoting the continued growth and development of our Octopot family and you are greatly appreciated.
Grow in Peace my Friends*

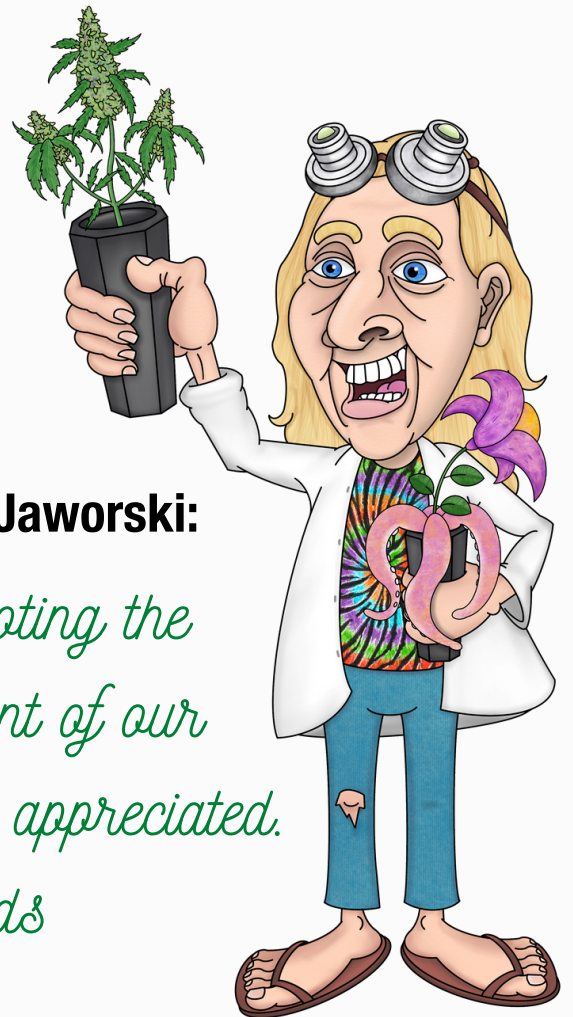

PRODUCTS AT A GLANCE

6 Gallon Lid, attached caps



3 Gallon Caps



6 Gallon Base



3 Gallon Depth Gage

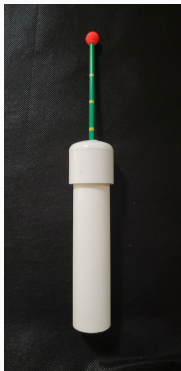

Hydro Wick



6 Gallon Depth Gage



3 Gallon Base



3 Gallon Control Reservoir

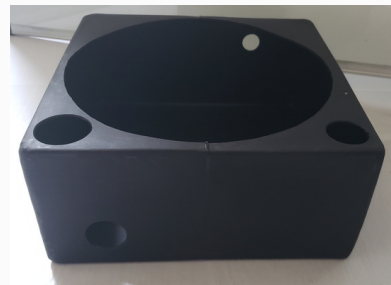

GROW MEDIA CONTAINMENT OPTIONS

Fits 3 and 6 Gallon Grow Systems

Original Grow Sleeve



Cupped Grow Sleeve

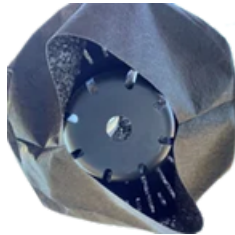

Strapped Grow Sleeve

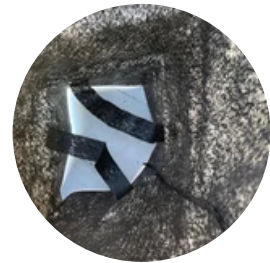

The 'OG' OctoGrid



Only Fits 6 Gallon Grow Systems

XXL 12 Gallon Grow Sleeve



The XXL OctoGrid



PRODUCT ASSEMBLY

3 Gallon Octopot Hybrid Grow System



- Place Hydro Wick® inside of Grow Sleeve with cup down, it should fit tight in the tapered end.
- Fold the top of the Grow Sleeve down no more than two inches to provide for proper moisture gradients.
- Set Grow Sleeve with Hydro Wick® into the Hydro Reservoir.
- Place Depth Gauge inside hole, as shown to the left
- Read System Requirements before filling with growing media.
- Follow Planting Instructions for planting seeds and clones.
- Follow Octo-Dome instructions for planting cuttings.

3 Gallon System Includes:

3 Gallon Hydro Reservoir Base, Hydro Wick, Standard Grow Sleeve,
& 3 Gallon Depth Gauge
3 Gallon Cap



6 Gallon Octopot Hybrid Grow System

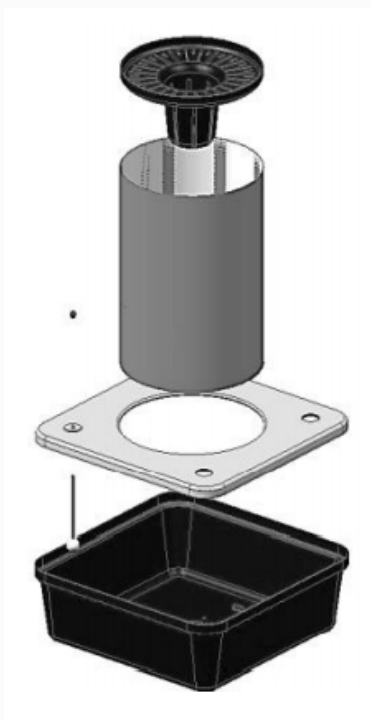

- Twist caps off Hydro Reservoir lid.
- Insert Depth Gauge into lid with white float down. Set orange ball on top.
- Fit lid inside Hydro Reservoir lip.
- Place Hydro Wick® inside of Grow Sleeve with cup down, it should fit tight in the tapered end.
- Fold the top of the Grow Sleeve down no more than two inches.
- Set Grow Sleeve with Hydro Wick® into the Hydro Reservoir.
- Place caps. (optional)
- Read System Requirements before filling with growing media.
- Follow Planting Instructions for planting seeds and clones.
- Follow Octo-Dome instructions for planting cuttings.

6 Gallon System Includes:

6 Gallon Hydro Reservoir Base & Lid, Hydro Wick, Standard Grow Sleeve, Depth Gage, & 4 Caps



Control Reservoir

- **Install Float Valve into Hydro Reservoir:**
 - **Insert Float Valve with one rubber washer on the inside of the Hydro Reservoir side wall.**
 - **Adjust the position of the Float Valve making sure that it will rise straight up to shut off.**
 - **Tighten nut firmly after positioning the Float Valve.**
 - **Connect the 1/2" Adapter to the outside of the float valve.**
- **Install a 1/2" (or 3/4") bulkhead in the lower hole on your control reservoir**

Control Reservoir Includes:

3 Gallon Hydro Reservoir Base, with pre-drilled holes, 1/2" adjustable float valve, & (1/2" bulkhead, 1/2" shut off valve, & 1/2" tubing) for external storage connection.

see auto-fill plumbing for external connection instructions



****The OctoBuoy was discontinued in 2021 replaced by an adjustable float valve**

Auto-Fill Plumbing

NOTE: Carefully measure space requirements and determine layout before cutting your tubing. This system is designed around the concept that water finds its own level. **Your Control Reservoir & Hydro Reservoirs must be on a level surface** (use shims if necessary)

Auto Fill Plumbing Includes: Bulkheads, Shut off Valves, Tees, & Tubing. Available in 1/2" and 3/4".

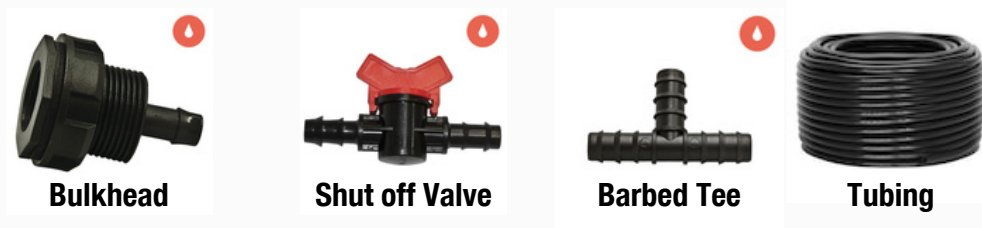

Assembly Guidelines:

- Install 1/2" bulkhead into your external water reservoir.
 - A 1 3/8" hole is required in your external reservoir
- Layout 1/2" tubing between your control reservoir and your external water reservoir.
 - Cut 1/2" tubing into two pieces
 - Connect one end of the first piece to the 1/2" bulkhead in the external reservoir
 - Connect 1/2" shut off valve on the other end
 - Connect second 1/2" piece of tubing to the other end of shut off valve
 - Connect the other end of the second piece to the control reservoir's float valve
- Install bulkhead fittings into the holes provided in each Hydro Reservoir.
 - Make sure the rubber gasket is installed on the inside of the Hydro Reservoir wall for each grow system
- Determine your optimal plant spacing and set all the Hydro Reservoirs in place.
- Layout tubing, tees, and drain valves
 - One shut-off valve is installed right after control reservoir and the other drain valve is installed at the end of the line
- After all components are laid out for appropriate spacing, measure and cut the tubing
- Assemble all plumbing
 - For easy installation, use a little lubricant on barbed ends of fittings and inside edge of tube



- **Slowly turn on water supply and check each Hydro Reservoir for leaks. Run water until it covers the bottom of all the Hydro Reservoirs to make sure each one is at the proper level. Adjust individual Hydro Reservoirs with shims or blocks as needed.**

NOTE: WHEN CHECKING FOR PROPER WATER LEVELS DURING INITIAL SET UP BYPASS THE FLOAT VALVE IN THE CONTROL RESERVOIR TO FILL HYDRO RESERVOIRS FASTER. SIMPLY RUN YOUR WATER SUPPLY DIRECTLY INTO THE TOP OF THE CONTROL RESERVOIR. CONTINUE THAT WAY TO FILL FOR FIRST TIME. BE SURE TO PLACE YOUR FLOAT VALVE BACK IN ITS PLACE, WHEN FINISHED.

Octo-Grid

The 'OG' 6 Gallon OctoGrid Includes:

Galvanized Steel 'Grid' - holds 6 Gallons of grow media, 2 braces, & Grid Liner

The 'XXL' 12 Gallon OctoGrid Includes:

Does not fit the 3 Gallon Octopot Hybrid Grow System

Galvanized Steel 'Grid' - holds 12 Gallons of grow media, 4 braces, & XXL Grid Liner

- Unroll the Octo Grid
- Place wire braces for Hydro Wick®
 - **6G: 2 Braces positioned in a V shape; across second horizontal wire up from the bottom.**
 - **12G: 4 Braces positioned in an # shape; across the first horizontal wire from the bottom.**
- Place Octo Grid into the Hydro Reservoir
 - **6G sits inside of the lid.**
 - **12G sits on top of the lid.**
- Insert Grid Liner inside Octo Grid
- Fold the Liner over top of the Octo Grid, and down the outside of the Grid
- Insert the Hydro Wick®



Brace Placement:

6 Gallon
V Shape



12 Gallon
Shape

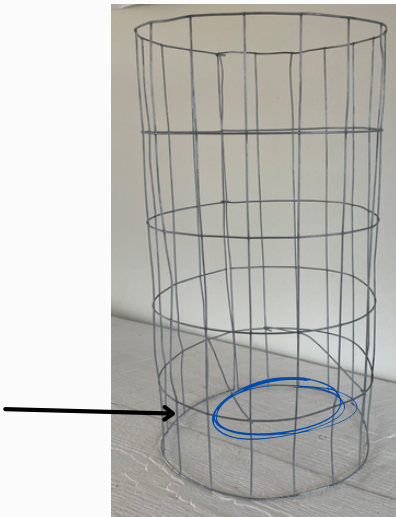
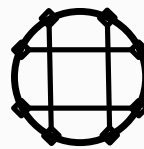

OctoDome

Use Octo-Dome Cloners with **all** Octopot® Grow Systems. Go from plant cutting to harvest in one container without transplanting.



Most plants will develop tap roots using this method. Tap roots are a super highway for nutrient uptake. Plants with tap roots grow faster and grow dense branching.

- Assemble your Grow System according to instructions.
- Follow Planting Instructions to prepare your grow system for the plant cutting
- Prepare plant cutting according to root stimulator or hormone instructions.
- Plant the cutting into the growing media of the Grow Sleeve/Grid Liner, **only one cutting per grow system**
- Water over the top of the growing media **just once** approximately one quart to half a gallon. Watering over the top at the time of planting settles the soil, removes air pockets and triggers capillary action.
 - Cuttings are well fed in the Octopot Grow System while they develop the secondary root system inside of the Hydro Reservoir. It is normal for the top layer of growing media to feel dry.
 - **WARNING** - Do not water over the top of the soil after initial planting. Plants sense water in the Hydro Reservoir and grow roots in that direction. See www.Octopot.com/how-octopots-work for information about Hydrotropism.
- Place plastic humidity dome over the arched wire frame.
 - For peat-based soil, the humidity dome should overlap the outside of the Grow Sleeve by only three to four inches. Fold the humidity dome about 4 inches up before placing onto the Octopot. Peat based soil may be too moist if the dome covers the entire Grow Sleeve.
 - When using coco coir, do not fold the humidity dome at all. Coco coir is dryer than peat-based soil and the extra moisture is needed for the cloning process.
 - When using the XXL OctoGrid or XXL Sleeves, wire frame and bag will not fit over entire surface. Place it directly over the center and roll the bag up as necessary.
- Watering Method:
 - For peat-based soil, add water to the Hydro Reservoir up to the first mark on the Depth Gauge. Maintain up to the low level of water for approximately 2 weeks to initiate the rooting process.
 - When using extremely light coco coir growing media keep the water level at the center mark of the Depth Gauge.
- The humidity dome has four ventilation holes in the top. If condensation builds up for more than 48 hours, simply enlarge the ventilation holes with scissors.
- Optimum room temperature for the Octo-Dome rooting process is 72 -75° Fahrenheit.
- Octo-Dome may be removed after approximately two weeks.

SYSTEM REQUIREMENTS

****For best results plant seeds, unrooted cuttings, or rooted clones in your Octopot Hybrid Grow System. Octopot facilitates plant root development, therefore transplanting mature plants with established root systems will not bear optimal results.**

Grow Media

Always follow the 60/40 rule! Specifically, use 60% high quality soilless mix with 40% perlite.



Sunshine Mix #4 is a professional blend that has the correct ratio needed for the Octopot. Premier Horticulture (HP) soil also contains the correct ratio.

Coco Coir Option



Always follow the 60/40 rule! Specifically, use 60% high quality Coco Coir with 40% perlite. Include organic amendments such as guanos, composts, composted manures, etc.

***Fox Farm Coco Loco is a professional blend that has the correct ratio needed for the Octopot, including the organic amendments necessary for success.**

Grow Media to Avoid

Do not use hydroton, clay pebbles, or rock wool.

Super soils can be too heavy and hold too much moisture, limiting air exchange which damages plants causing root rot. Also, nutrients in super soils tend to be used up too early and run out too soon in the growth cycle, which starves the plant. Super soil may work with the Octopot, IF it has the correct ratio of perlite (40%) and enough controlled release nutrients to support two root systems, not just one.

PLANTING INSTRUCTIONS

- **Assemble your Octopot Grow System according to instructions.**
- **Review System Requirements before choosing growing media and watering method.**
- **Fold down the Grow Sleeve no more than 2 inches at the top (Does not apply for Octo-Grid Liners)**
- **Moisten the growing media by adding some water to the bag before filling the Grow Sleeve.**
 - **If using un-amended media, add organic amendments when moistening**
- **Be sure that your growing media has 40% perlite mixed well throughout – never create layers of perlite and growing media.**
- **FIRMLY press moistened growing media into the Hydro Wick® before filling the Grow Sleeve.**
- **Pull Grow Sleeve gently upwards while FIRMLY PACKING growing media, make sure to pack well along the outside edges – firmly packed Grow Sleeves should not slouch during the growth cycle.**
- **Alternative Filling Method:**
 - **Cut the bottom out of a standard five-gallon bucket.**
 - **Place Hydro Wick® inside of Grow Sleeve with cup down, it should fit tight in the tapered end.**
 - **Set Grow Sleeve with Hydro Wick® into the Hydro Reservoir.**
 - **Place the bucket upside down over the Gro Sleeve.**
 - **Fold Grow Sleeve edge over the bucket**
 - **The support of the bucket makes packing the growing media FIRMLY into the Grow Sleeve easier.**
 - **Simply remove the bucket by pulling it upward after filling the Grow Sleeve.**
 - **Fold the top of the Grow Sleeve down no more than two inches. .**
- **Insert seed, unrooted cutting, or rooted clone into the grow media of the Grow Sleeve – only one plant per grow system.**
 - **Follow the directions for Octo-Dome® Cloner for seeds & unrooted cuttings.**
 - **Transplanting mature plants with an established root systems is not recommended for anything exceeding 3 gallons in size.**

- **Water over the top of the growing media just once approximately one quart to half a gallon. Watering over the top at the time of planting settles the soil, removes air pockets and triggers capillary action.**
 - **Young plants and seeds are well fed in the Octopot Grow System while they develop the secondary root system inside of the Hydro Reservoir. It is normal for the top layer of growing media to feel dry.**
 - **WARNING-Do not water over the top of the soil after initial planting. Plants sense water in the Hydro Reservoir and grow roots in that direction. For more information see www.Octopot.com/how-octopots-work for information about Hydrotropism**
- **Choose a watering method (See System Requirements-Watering) then add water to the Hydro Reservoir according to your preferred watering method.**
- **Add pre-mixed nutrients/water into the Hydro Reservoir.**
 - **Note: Adding fertilizer at the time of planting can be delayed if your growing media is already infused with fertilizer. (See System Requirements-Nutrients)**

NOTE: PLANTS GROW ROOTS BEFORE SHOOTS, SO DON'T WORRY IF THE PLANT APPEARS UNCHANGED FOR A WEEK OR SO.

Nutrient Requirements

Add premixed water soluble organic or conventional fertilizers and nutrients directly to the Hydro Reservoir. Adding fertilizer at the time of planting can be delayed if your growing media is already infused with fertilizer.

Note: You may find that you are using less nutrients with our Hybrid Grow Systems.

Why? Because Octopot Hybrid Grow Systems are closed systems that never waste fertilizer or nutrients from washout or run off.

THE RULE FOR OCTOPOT IS: LESS IS MORE

pH & PPM

pH performs an enormous role in PPM concentrations. PPM can be spot on but if pH is off, PPM is rendered meaningless because the plants can't absorb the nutrients they need.

Learning to adjust PPM and pH can be challenging. As you adjust one, the other will react. As a rule of thumb, it is more important for pH levels to be correct than PPM levels.

The use of a TDS or EC meter to measure PPM is a precise way of ensuring that your plants receive exactly the right amount of nutrients.

Note: EC and TDS water meters fit into the Octopot reservoir hole, making it simple to measure and control feeding!

CANNABIS SPECIFIC RECOMMENDATIONS

These are only guidelines; please observe your plants and research your strain for more detail specific guidance.

- Throughout the plant's life cycle, cannabis plants have distinct nutritional needs.
- There is an optimal level of PPM & pH for each phase of development.

PPM Levels

Indica

Growth - 18 hour photoperiod

- Seedling Stage - 100-400
- Early Vegetation - 500-800
- Late Vegetation - 800-1200

Bloom - 12 hour photoperiod

- Early Flower - 1200-1400
- Mid Flower - 1400-1600

Harvest

- Late Flower - 1000-500-0

Sativa

Growth - 18 hour photoperiod

- Seedling Stage - 100-400
- Early Vegetation - 400-500
- Late Vegetation - 500-600

Bloom - 12 hour photoperiod

- Early Flower - 600-800
- Mid Flower - 800-900

Harvest

- Late Flower - 800-500-0

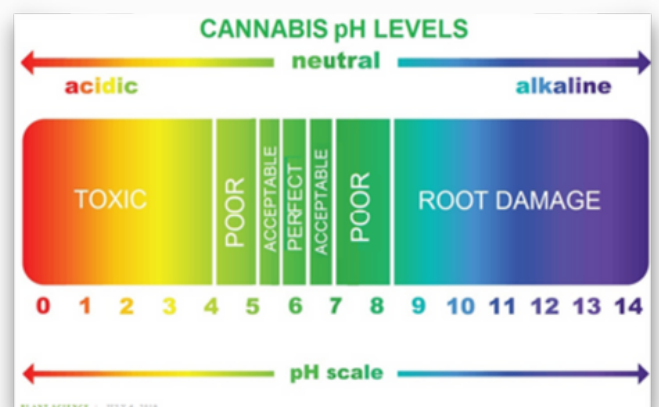

Optimal pH Range

After mixing nutrient solution or fertilizers, test your pH and adjust your pH if needed, to between 5.5 - 6.5, before adding the solution to your reservoir. This is the optimal range for your Octopot Hybrid Grow System.

NOTE: PH SWINGS WILL OCCUR AS NUTRIENTS ARE TAKIN IN BY THE PLANT DURING ITS GROWING CYCLE.

pH affects the availability of nutrients that a plant can absorb during the growth cycle. pH is a RANGE, not an exact number.

Watering

Octopot Hybrid Grow Systems will water plants for up to 10 days, depending on the size and stage of the plant. Use to depth gage to determine when to fill your reservoir.

Warning: Do NOT water plants over the top of the soil after initial planting. It will prevent the hydro roots from forming properly. Plants sense water down in the Hydro Reservoir and grow in that direction. Check out our website for more on [Hydrotropism!](#)

Growing Outdoors: Rain water will escape the system so plants are never over watered. Excessive rain water during early stages of plant growth may prevent root growth into the Hydro Reservoir.



If you let the Hydro Reservoir go dry for an extended period of time, you can kill the hydroponic root system. Typically the terrestrial roots inside the Grow Sleeve/Liner will stay alive for days after the loss of the hydroponic root system, keeping your plants alive.

Follow these steps to Recover from Dehydration:

- Remove any dead roots inside the water/reservoir
- Refill the Hydro Reservoir with fresh water, and continue growing!

Choose a Watering Method

Set it and Forget it

1. Fill the Hydro Reservoir at the time of planting
2. Refill anytime, just maintain a water level **NO LESS THAN** Level 1

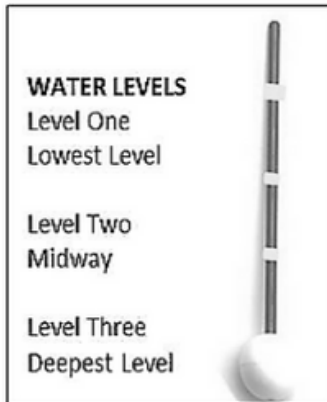

For the Octo Buoy:
Level 3 = No Buoy
Level 2 = Single Buoy
Level 1 = Double Buoy



Auto-Fill Float Valve Settings

The original design included the use of a 1/4" fixed valve, paired with Octo Buoys. This design was discontinued in 2021, and replaced with a 1/2" adjustable float valve, no Octo Buoy required.

How to Set you're Adjustable Float Valve

- Start by finding the neutral position
- The lines will be in line with each other, on both sides of the adjuster
- Level 3 = Neutral
- Level 2 = One Click Forward
- Level 1 = Two Clicks Forward



Push the float down for "forward" and pull up for "backwards"



High Performance Method

GROW PHASE

18-24 hr light schedule

- Weeks 1-2: Maintain below Level 1 - Root Migration into the Hydro Reservoir (Approx 2-3 weeks)
- Weeks 3-5: Maintain Level 2 - Aids in Root Establishment and Advancement (Approx 2-3 weeks)

12/12 hr light schedule

1. Weeks 6+: Maintain Level 3 - Maximizes Plant Growth (Approx 4-6 weeks)

HARVEST PHASE

- Last 2-3 Weeks: Maintain Level 2 - Plant Growth begins to Slow
- Last 1-2 Weeks: Maintain Level 1 - Plant Growth preparing for Harvest

Flushing

- **Individual Octopot Hybrid Grow Systems**
 - To flush a plant at the end of the growing season, simply stop adding fertilizer/nutrients to the Hydro Reservoir for the last 7-10 days and add fresh water instead
- **Auto-Fill Hybrid Grow Systems**
 - When using the Auto-Fill system, simply shut off the water source and open the line to drain the system to empty. Refill with fresh water!

There is NO reason to drain Octopot Hybrid Grow Systems DURING the grow cycle, unless you have over-fertilized your plant

Follow these steps to Recover from Over-Fertilization:

- Empty the reservoir with a small pump, siphon, or shop vac
- Remove any dead roots inside the water/reservoir
- Refill the Hydro Reservoir with fresh water, and continue growing!

In drastic cases, you may need to flush the soil and remove the leachate.

Octopot Enhancement Notes

Air Stones

Octopot Hybrid Grow Systems are designed to oxygenate plants without Air Stones. Octopots are a passive, not active, hybrid hydroponic system. Adding Air Stones to your Octopot can negatively affect the amount of dissolved oxygen in the water, causing wider pH swings.

If you feel the use of Air Stones is necessary, or just want to try:

- Run 10-15 min per hour, at low pressure

BENDING THE RULES FOR ORGANIC TEAS

Suspending heavy Organic Teas in the Hydro Reservoir may require the addition of an Air Stone to keep nutrients well mixed.

Octopots are bottom fed systems, and top watering/feeding is not generally recommended. However, organic nutrients can be washed into the soil approximately once per week.

More to come on the following Topics (WIP):

- Recirculating Pumps
- Ventilation
- Lighting
- Humidity Control
- Temperature Control
- IPM

OCTOPOT ONE YEAR SATISFACTION GUARANTEE

If for any reason you are not completely satisfied with your Octopot-branded product, simply return it within one year for a full refund of your purchase price.

This guaranty only applies to Octopot-branded products purchased directly from Octopot LLC, and does not include shipping and handling.

You can return your Octopot-branded product and receive your full refund in the following ways:

- Use the Contact form at [Octopot.com/warranty](https://www.octopot.com/warranty)**
- Email sales@octopot.com to begin the process with one of our staff**
- Call us at 855-628-6768 during normal business hours (EST), Monday through Friday, 9:00 a.m. to 5:00 p.m.**

A copy of your receipt or other proof of purchase is necessary for a full refund.

Used items must be cleaned before returning to avoid handling fees. If there is a problem with your Octopot-branded product, please see Octopot Limited Warranty for warranty service.

Octopot is available via email, telephone, Facebook Messenger (available on our website as well). We gladly welcome customer communication and are willing to help you along the way, should you need our assistance in any way! Our goal is 100% Customer Satisfaction!

OCTOPOT, LLC

LIMITED WARRANTY

This product has been manufactured by Octopot, LLC ("Octopot") and this warranty is our promise to you to stand behind our product. This warranty is non-transferable and extends only to you as the original purchaser of a new product from Octopot or its authorized resellers. This warranty applies to warranty service only. If for any reason you are not satisfied with your Octopot-branded product, please see Octopot's one-year 100% satisfaction guarantee for a full refund. Nothing in this warranty is meant to limit our promise to you and your rights under our guarantee.

What Does This Warranty Cover?

- **This warranty covers any defects in materials or workmanship in the following parts ("Warranted Parts") and gauges ("Warranted Gauges"):**
 - **30 Day Warranted parts: Grow Sleeve, 6 Gallon Depth Gauge, 3 Gallon Depth Gauge**
 - **5 Year Warranted Parts: 6 Gallon Hydro Reservoir, 6 Gallon Base, 6 Gallon Lid, Hydro Wick, 3 Gallon Hydro Reservoir**

During the applicable warranty period, Octopot will replace any Warranted Parts or Warranted Gauges that fail under normal use as a result of a defect in material or workmanship and has been used according to Octopot's published instructions. This remedy of replacement is the exclusive remedy to you under this warranty, and Octopot gives no other guarantee, warranty, or condition, express, statutory, or implied. No one else, including, without limitation, Octopot's agents or authorized resellers, may give you any guarantee, warranty, or condition on Octopot's behalf which is contrary to this warranty.

What Does This Warranty Not Cover?

- **This warranty does not cover:**
 - **Products sold outside the United States or Canada**
 - **Products that are used contrary to Octopot's published instructions**
 - **Product damages as the result of extreme weather conditions (0 °F/−17.8 °C)**
 - **Products subject to accident, mishandling, negligence, alteration, abuse, or misuse**
 - **Scratched, dented, or other cosmetic damage**
 - **Repairs made by anyone other than Octopot**

What is the Period of Coverage?

- **This warranty begins on the date you purchased the product and extends for five years for Warranted Parts and 30-days for Warranted Gauges. If a Warranted Part or Warranted Gauge fails after its applicable warranty period expires, there is no warranty of any kind.**

How Do You Get Warranty Service?

- **Warranty service can be obtained following the online process at www.octopot.com/warranty. If you do not have internet access, you can call (855) 628-6768 (EST) during normal business hours, Monday through Friday, 8:00 a.m. to 5:00 p.m. EST. To get warranty service, you will be required to ship your Warranted Part and/or Warranted Gauge to Octopot at your cost, together with a copy of your receipt or other proof of purchase.**

What Will Octopot Do?

- **After you return your Warranted Part and/or Warranted Gauge to Octopot (together with a copy of your receipt or other proof of purchase), Octopot will inspect it. If Octopot determines that the Warranted Part and/or Warranted Gauge is defective in material or workmanship during the warranty period, and the defect is otherwise covered by this warranty, Octopot will replace it at no charge to you. Unless restricted by law, replacement may be with a new or refurbished part or gauge. After replacement, your replaced Warranted Part and/or Warranted Gauge will be covered by this warranty for the longer of the remainder of the original warranty period, or 90 days after Octopot ships it to you. Octopot's sole responsibility is to replace defective Warranted Parts and Warranted Gauges. You are not entitled to a refund under this warranty under any circumstances.**

How Does State/Province Law Relate to This Warranty?

- **The law of your State or Province may give you an implied warranty, including an implied warranty of merchantability or fitness for a particular purpose. The duration of that implied warranty is limited to the applicable warranty period. Some States or Provinces do not allow limitations on how long an implied warranty lasts, so this limitation may not apply to you. Likewise, some states do not allow the exclusion or limitation of incidental or consequential damages, so the limitation or exclusion of damages below may not apply to you.**

THIS EXPRESS WARRANTY IS MADE IN LIEU OF ALL OTHER WARRANTIES, EXPRESSED OR IMPLIED, INCLUDING, WITHOUT LIMITATION, THE IMPLIED WARRANTIES OF MERCHANTABILITY AND FITNESS FOR A PARTICULAR PURPOSE, ALL OF WHICH ARE HEREBY DISCLAIMED, AND IS MADE IN LIEU OF ALL OTHER OBLIGATIONS AND LIABILITIES OF OCTOPOT. OCTOPOT NEITHER ASSUMES, NOR AUTHORIZES ANY OTHER PERSON TO ASSUME FOR OCTOPOT, ANY OTHER LIABILITY IN CONNECTION WITH THE SALE OF THE PRODUCT. IN NO EVENT SHALL OCTOPOT, NOR ANY OF ITS AUTHORIZED REPRESENTATIVES, BE LIABLE FOR ANY COMMERCIAL LOSS OR SPECIAL, PUNITIVE, INDIRECT, INCIDENTAL, OR CONSEQUENTIAL DAMAGES.